

Carbon Fiber Reinforced Polymer [CFRP] Wrap/Fabric High Tensile Strength

Pioneer in CFRP,
Smart & Clever for Composites

Structural Strengthening
Building & Civil Engineering
[Column, Beam & Slab]

Timber Strengthening

Masonry Strengthening

Build Wrap HS

Weight of Wrap & Wide Products List

- 200g/m² x 500mm x 100/m roll
- 230g/m² x 500mm x 100/m roll
- 300g/m² x 500mm x 100/m roll
- 450g/m² x 500mm x 50/m roll
- 530g/m² x 500mm x 50/m roll
- 600g/m² x 500mm x 50/m roll



Build Wrap HS 200, 300 & 600

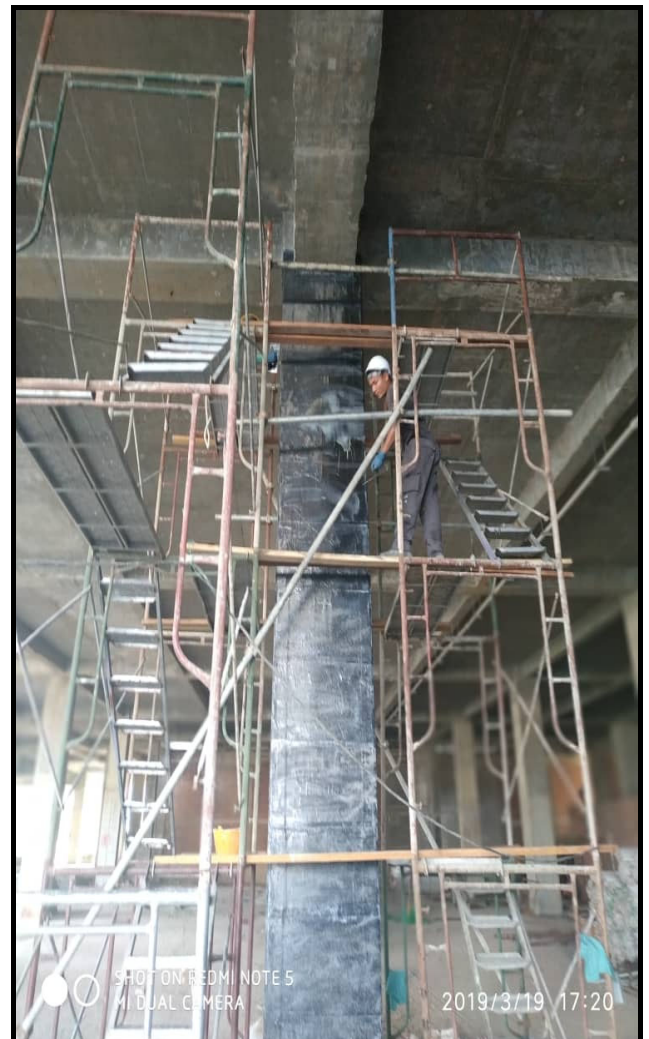

Build Wrap HS 300 apply on Column

Carbon Fiber Reinforced Polymer [CFRP] High Tensile Strength [HS]

Build Wrap HS

is a fabric sheet of longitudinal oriented, continuous carbon fiber filaments which are held in position by a lightweight, open mesh, glass scrim. **Build Wrap HS®** has robust handling and rapid wet-out characteristics which make it ideal for on-site strengthening of structural of buildings, bridges, beams, columns and marine structures. Additionally, **Build Wrap HS®** is compatible with all commonly used resin systems which can be applied using a variety of wet-out/resin infusion techniques.

Is a composite material for the reinforcement of new and the strengthening of existing structures. The materials excellent resistance to most of forms of corrosions and the ability to dissipate energy as required in earthquake scenarios make them eminently suitable for a wide rage of applications and they contribute significantly to lowering life cycle costs and increasing safety.

History Carbon Fiber

Is produced by the controlled oxidation, carbonization and graphitisation of carbon-rich organic precursors which are already in fiber form. The most common precursor is polyacrylonitrile (PAN), because it gives the best carbon fiber properties, but fibers cal also be made from pitch or cellulose. Variation of the graphitisation process produces either high strength fibers (@2,600°C) or high modulus fibers (@3,000°C) with other types in between. Once formed, the carbon fiber has a surface treatment applied to improve matrix bonding and chemical sizing which serves to protect it during handling

Key Properties

- ❖ High Tensile Strength
- ❖ High Thermal Conductivity & Electrical Conductivity
- ❖ Light Weight & Transparent to X-Rays
- ❖ Excellent Fatigue & Corrosion Resistance
- ❖ Low Friction and Wear & Low Thermal Expansion
- ❖ Resistance to High Temperatures
- ❖ Good Creep and Damping Properties
- ❖ Solvent Free Working Environment & Non-Toxic

Uses

**for Strengthening Reinforced Concrete
Masonry, Timber Wood & Steel**

Loading Increase

Increase of Supporting Live Load in Building
Increase of Supporting Traffic Growth on Bridges
Vibrating Machinery on Roof Slabs
Heavy Machinery in Commercial Building

Change Design for Structural System

Dismantlement of Walls & Columns
Dismantlement of Slabs & Beam
Reducing of Buildings & Bridges Weight

Design or Construction Defects

Insufficient Reinforcements
Insufficient Structural Depth

Build Wrap HS

CFRP Wrap/Fabric

6 types of weight for **Build Wrap HS** Carbon Fiber Physical Properties

Products Grade	Build Wrap HS200		Build Wrap HS230		Build Wrap HS300	
Carbon Fiber Weight	200	g/m ²	233	g/m ²	300	g/m ²
Roll Width	500	mm	500	mm	500	mm
Roll Length	100	meter	100	meter	100	meter
Sheet Thickness	0.107	mm	0.120	mm	0.167	mm
Typical Binder Content	3.0	%	3.0	%	3.0	%
Total Roll Weight	10.00	kg	11.65	kg	15.00	kg

Products Grade	Build Wrap HS450		Build Wrap HS530		Build Wrap HS600	
Carbon Fiber Weight	450	g/m ²	530	g/m ²	600	g/m ²
Roll Width	500	mm	500	mm	500	mm
Roll Length	50	meter	50	meter	50	meter
Sheet Thickness	0.235	mm	0.276	mm	0.325	mm
Typical Binder Content	3.0	%	3.0	%	3.0	%
Total Roll Weight	22.50	kg	13.25	kg	15.00	kg

Specification Properties Data Sheet

“Build Wrap HS®” - Carbon Fiber Filament Yarn [Actual Dry Fiber] Properties

Typical of Carbon Fiber Properties	SI / Units UK design		US / Units US design	
Tensile Strength	4,900	Mpa	710,500	psi
Tensile Modulus	230	Gpa	32.80 x 10⁶	psi
Ultimate Elongation	1.80	%	1.80	%
Density	1.79	g/cm ³	0.0646	Ib/in ³
Approximate Yield (12K)	1.31	m/g	1,950	Ft/Ib
Filament Diameter	6.7	µm	0.265	mil

Properties, Cured Laminates, [Final Performance] Carbon Fiber Reinforced Polymer

Build Wrap HS	Test Method	UK Design	US Design
Tensile Strength	ASTM D3039	>2800-3000 Mpa	406,000-435,000 psi
E-Modulus	ASTM D3039	165 Gpa.	24.00 x 10 ⁶ psi
Flexural Strength	ASTM D790	1850 Mpa	268,250 psi
Fiber Volume [by weight]	ASTM D3039	70%	70%
Epoxy Resin Volume	ASTM D3039	30%	30%
Density Composite	ASTM D3039	1.60 g/cm ³	1.60 g/cm ³
Elongation at Break	ASTM D3039	1.61-1.70 %	1.61-1.70%
Temperature Resistance	ASTM D3039	>150°C	>150°C

Carbon Fiber Wrap/Fabric Sheet for Dry and Wet Lay up

Technical Data [Unidirectional]	Build Wrap HS 200	Build Wrap HS 300	Build Wrap HS 450	Build Wrap HS 600
Carbon Fiber Weight [g/m ²] main direction	200	300	450	600
Density [g/cm ³]	1.79	1.79	1.79	1.79
Elongation at Rupture [%]	1.60	1.60	1.60	1.60
Design Thickness [Fiber Weight/Density] [mm]	0.107	0.167	0.235	0.325
Theoretical Design Cross Section 100mm Width [mm ²]	107	167	235	325
Reduction Factor for Design [Manual Lamination/UD Sheet]	1.2 (recommended by LaMaCo)	1.2 (recommended by LaMaCo)	1.2 (recommended by LaMaCo)	1.2 (recommended by LaMaCo)
Tensile Force of 1000mm Width Ultimate [kN]	$\frac{107 \times 3000}{1.2} = 267$	$\frac{167 \times 3000}{1.2} = 417$	$\frac{235 \times 3000}{1.2} = 587$	$\frac{325 \times 3000}{1.2} = 812$
Tensile Force of 1000mm Width at 0.6% ε for Design [kN]	160	250	352	487
Application	Flexural Enhancement (low quality of substrate) Axial Load Enhancement of Columns Replacement of Stirrups in Columns			



Build Wrap HS 300, apply on Column



Build Wrap HS 300, apply on Column

Application Method

Surfaces Preparation

Reinforced concrete surfaces shall be clean, structurally sound and free from foreign materials, contaminants, oily and other debris. Concrete surfaces shall not be more than 4% in moisture content and the temperature of the substrate must be at least 3°C (or) and above the current dew point temperature.

Reinforced concrete surfaces shall be clean, structurally sound and free from foreign materials, contaminants, oily and other debris. Concrete surfaces shall not more than 4% moisture content and the temperature of the substrate must be at least 3°C (or) and above the current dew point temperature.

For filing surface irregularities such as blowholes, honeycombs & etc. Please hack or cut off any unloose concrete, air blow excess dust, clean all concrete surfaces, and remain dry over night.

Use patching method of Polymer Cementitious Mortar or pumping of High Strength Cementitious Grout. But only for concrete surfaces cracks 0.25mm, must be injected with Low Viscosity of Epoxy Resin to be filled. Using high pressure Air-Less Pump for injecting and penetration into structural crack lines, to achieve load bearing and adhesion bonding system.

Once patched, pumped or injected, before laying Carbon Fiber Laminates, all surfaces must be Hammer Tested for Polymer Cementitious Mortar, High Strength Cementitious Grout and Pull-Off Test for Cracks Lines. For achievement of strength requirement please consult your local Engineer.

Over Head Application Vertical Application

Applied on Over Head or Vertical Beam and Slab, either Primer, Adhesive & Resin, Waste of materials are approximately 15%.

Mixing of Primer

Use a low speed (300 to 500 rpm) electric drill fitted with a paint mixer or a wing type paddle Pour one unit of Part A & B into drum and mix for at least 3 minutes until the mix is uniform and free. (Note: Once been mixed, the Primer must be applied within 30 minutes of Pot Life).

For Uneven Surfaces Mixing of Paste Putty

Use a low speed (300 to 500 rpm) electric drill fitted with a paint mixer or a wing type paddle. Pour one unit of Part A & B into drum and mix for at least 5 minutes until the mix is uniform and free. (Note: Once have been mixing, the Paste Putty must be applied within 60 minutes of Pot Life).

Mixing of Resin Wrap

Use a low speed (300 to 500 rpm) electric drill fitted with a paint mixer or a wing type paddle. Pour one unit of Part A & B into drum and mix for at least 3 minutes until the mix is uniform and free. Note: Once have been mixed, the Epoxy Resin or Polyurethane Resin must be applied within 60 minutes of Pot Life.

System Recommended Use Resin Component

Epo Resin Wrap is Epoxy Solvent Free (Bisphenol-F)
Two Component of Part A & Part B.
Suitable for applying on Over Head or Vertical or Horizontal Surfaces

Easy Installation The easy to use Carbon Fiber Wrap/Fabric system components assure fast, user friendly installation. A complete system is installed in only six (6) steps to properly prepared surfaces within appropriate working conditions.

1. **Preparation of Structure, Level the Un-even Surfaces with "Cem Strength"**
Apply **Cem Strength**, applied at rate 2 kg/m² to 12 kg/m², polymer cementitious mortar is a material that is applied using a squeegee or trowel to level uneven concrete surfaces. (Curing time: ½ hour to 4 hours depend of whether temperature)
2. **Roll "Epo Bond Primer"**
Apply **Epo Bond Primer**, applied at rate 0.20 kg/m² to 0.30 kg/m², and applied using a roller. (Curing time: 2-4 hours)
3. **Apply First Coat of "Epo Resin Wrap"**
Apply **Epo Resin Wrap**, applied at rate 0.25 kg/m² to 1.00 kg/m², is a high solids Epoxy Based Resin that can be applied using a roller to begin saturation of the fiber reinforcement sheet. (Curing time: ½ hour to 4 hours depend of whether temperature)
4. **Apply Carbon Fiber Wrap/Fabric Sheet of "Build Wrap HS"**
The backbone of the Carbon Fiber composite strengthening system, carbon fiber fabric sheet, to be placed into the first layer of wet saturant and backing paper is removed. During the laying of Carbon Fiber Fabric Sheet, Keep the fiber direction properly.
5. **Apply Second Coat of "Epo Resin Wrap"**
Apply **Epo Resin Wrap**, applied at rate 0.25 kg/m² to 1.00 kg/m², is a high solid Epoxy Based that can be applied using a roller to begin saturation of the fiber reinforcement sheet. (Curing time: ½ hour to 4 hours depend of whether temperature)
6. **Note: Apply Optional Topcoat**
Where required, the Carbon Fiber high solids, high gloss, corrosion-resistant topcoat provides a protective/aesthetic outer layer. (Refer to Manufacture)
In the case of two layers and several layers of "Build Wrap HS". For multiple plies repeat steps 3, 4 and 5. All direction of fiber overlapping must be at least 100mm

Manufacturer by:

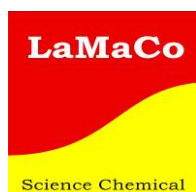

LaMaCo System Sdn Bhd

407, Jalan Perusahaan 6,
Taman Bandar Baru Mergong,
05150 Alor Star, Kedah. Malaysia
Tel : +60-4-734 5555
Fax : +60-4-772 4444
Http : www.lamaco.com
Email : info@lamaco.com

Important 1: While the information and data sheet contained in this promotional literature are presented in good faith and believed to be reliable, they do not constitute a part of our terms and conditions of sales unless specifically incorporated in our Order acknowledgement. Nothing herein shall be deemed to constitute a warranty, express or implied, that said information or data sheet are correct or that the products described are merchantable or fit for a particular purpose, or that said information, data sheet or products can be used without infringing patent of third parties.

Important 2: **LaMaCo Malaysia** products are not guaranteed against defective materials and manufacture & are sold subject to its standard Terms & Conditions of sale, copies of which may be obtained on request. Whilst **LaMaCo Malaysia** endeavors to ensure that any advice, recommendation, specification or information is accurate and correct, it cannot- because it has no direct or continuous control over where or how its products are applied – accept any liability either directly or indirectly arising from the use of its products, whether or not in accordance any advice, specification, recommendation or information given by it.

Health & Safety Some of the components of this product may be hazardous during mixing and application. Please consult the relevant Health & Safety Data Sheets, available from **LaMaCo Malaysia** on request and sent with each delivery.

Test Accordingly to ASTM D3039, Cured Laminates of CFRP Polymer Matrix Composite Products Putruccion Type of CFRP Strip/Plate/Tape

Achieving Test Result

Product Name	Tensile Strength [Mpa]	E-Modulus [Gpa]	A Fiber Thickness mm	B Fiber Width mm	Fiber Length mm	C Max Tensile Load [kN]
Build Wrap HS200	3000	165	0.107	25	250	8,025
Build Wrap HS230	3000	165	0.120	25	250	9,000
Build Wrap HS300	3000	165	0.167	25	250	12,525
Build Wrap HS450	3000	165	0.235	25	250	17,625
Build Wrap HS530	3000	165	0.276	25	250	20,700
Build Wrap HS600	3000	165	0.325	25	250	24,375

*Tensile capacity was calculated as $\frac{C}{A \times B}$



Specimen Sample: CFRP Wrap for 300gm/m²



Sample Tested: CFRP Wrap for 300gm/m²

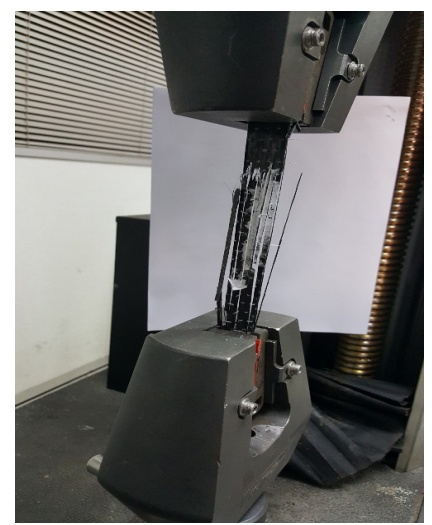
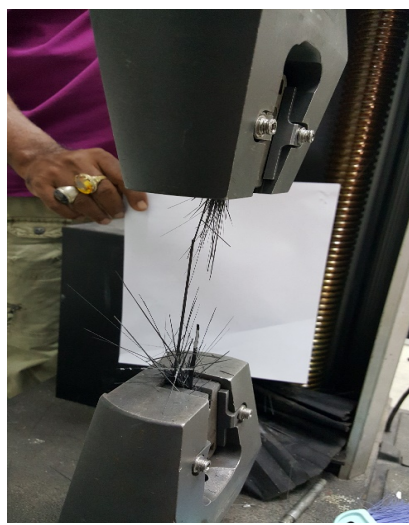

Tensile Strength Testing Equipment, Method of Tester Installation,
Once Tested the CFRP Cured Laminates or CFRP Pultrusion Laminates Breaking

Composite tensile specimen for measurement of longitudinal properties E_1 and $S_L^{(+)}$

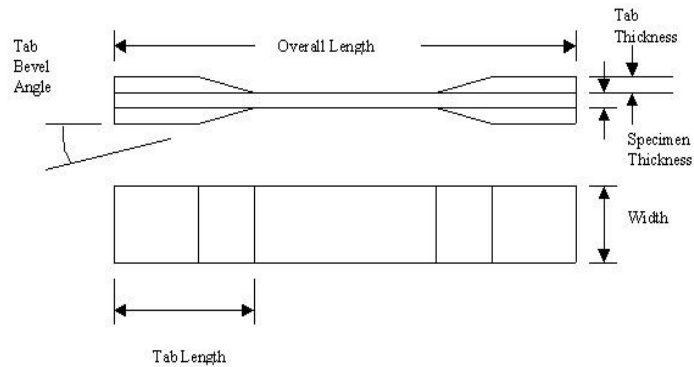

Fiber Orientation	Width, mm [in.]	Overall Length, mm [in.]	Thickness, mm [in.]	Tab Length, mm [in.]	Tab Thickness, mm [in.]	Tab Bevel Angle, °
0° unidirectional	15 [0.5]	250 [10.0]	1.0 [0.040]	56 [2.25]	1.5 [0.062]	7 or 90
90° unidirectional	25 [1.0]	175 [7.0]	2.0 [0.080]	25 [1.0]	1.5 [0.062]	90
balanced and symmetric random-discontinuous	25 [1.0]	250 [10.0]	2.5 [0.100]	emery cloth	—	—
	25 [1.0]	250 [10.0]	2.5 [0.100]	emery cloth	—	—

Specimen geometry for ASTM D3039/D3039M-08 standard tensile test. (Dimensions from ASTM D3039/D3039M-08. Copyright ASTM International. Reprinted with permission.)

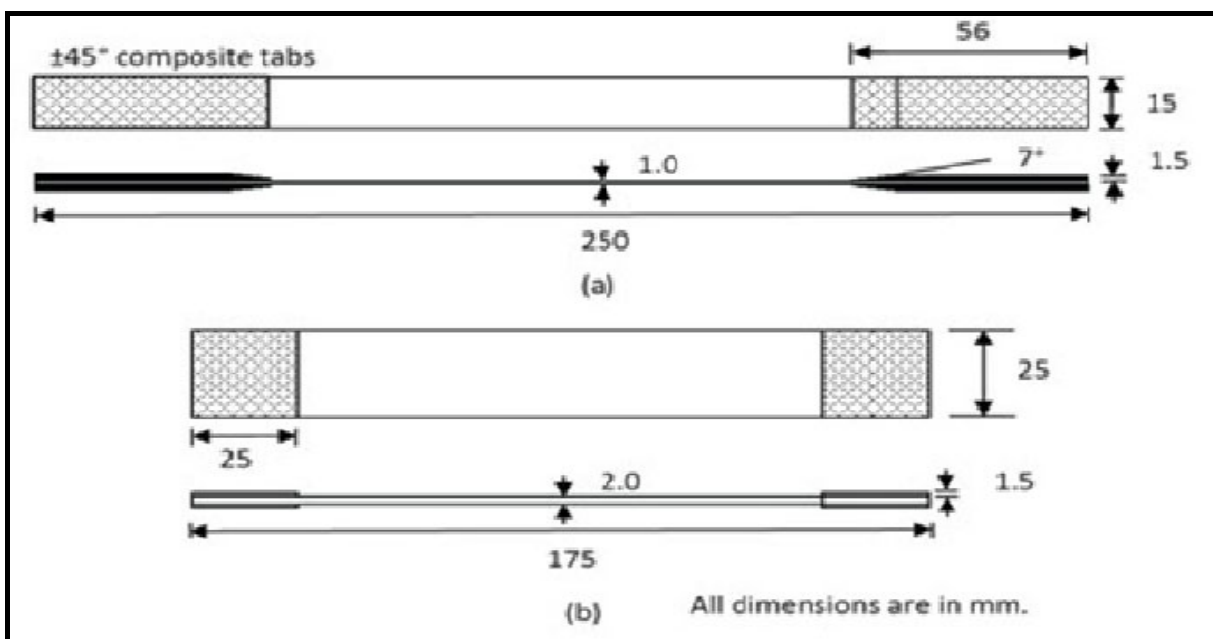

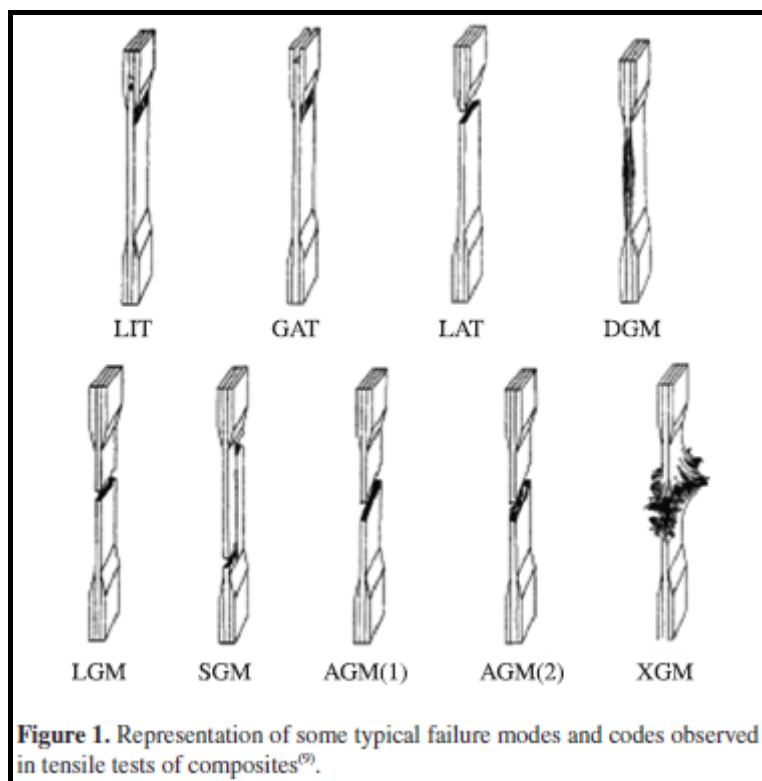

ACI 440.3R-12

**Guide Test Methods for Fiber-
Reinforced Polymer (FRP)
Composites for Reinforcing or
Strengthening Concrete and
Masonry Structures**

Reported by ACI Committee 440



American Concrete Institute®